

Standard Series SV40-900022

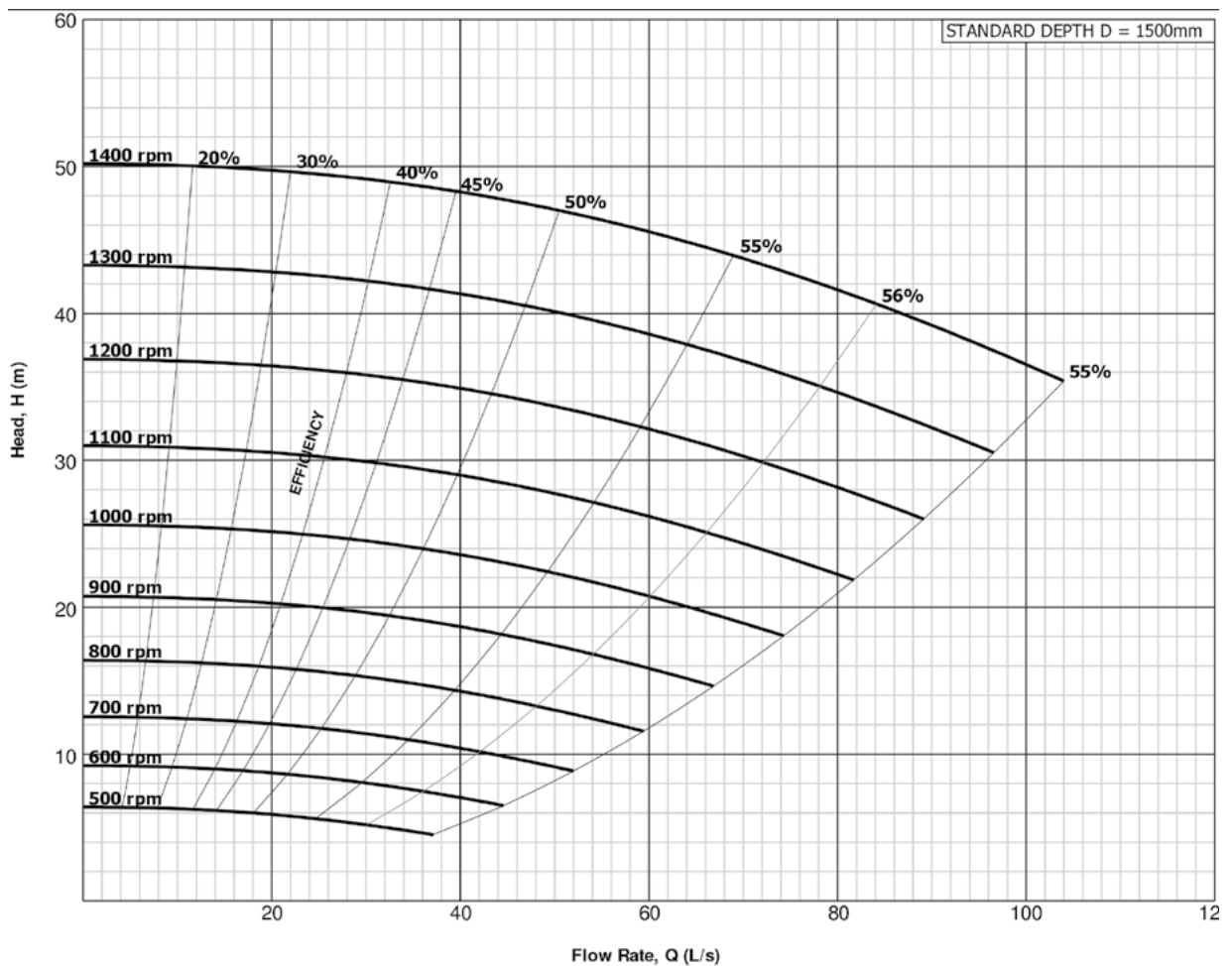

Suction	N/A
Discharge	100 mm (4")
Maximum RPM	1400
Sealing system	N/A
Impeller material	High chrome
Liner material	High chrome
Throat bush	N/A
Maximum motor power	75 kW
Weight-Bare shaft pump	930 kg



NOTE This information is for guidance/reference only. For application specific drawings and curves, please contact your nearest authorised distributor at slurrypro.com

Standard Series SV40-900022

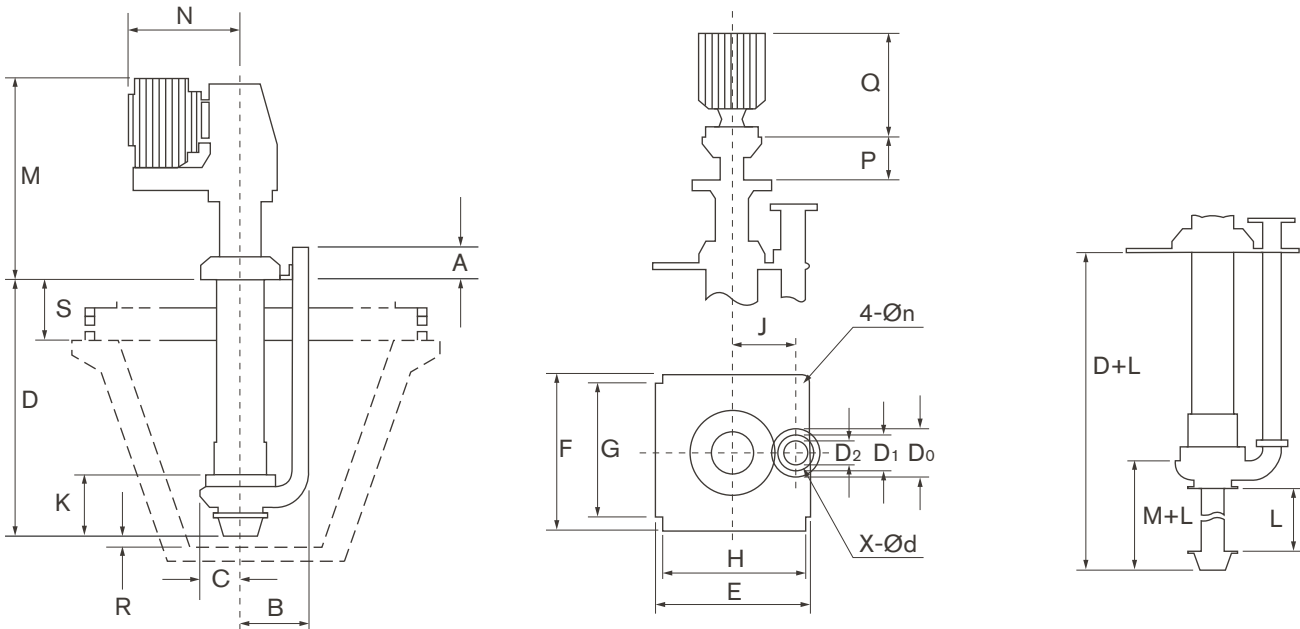

PUMP		A	B	C	D		E	F	G	H	J	Øn	K	M	N	P	Q	PUMP WEIGHT (kg)	S	DISCHARGE FLANGE SIZE			
TYPE	FRAME				NOTE: These are maximum dimensions based on largest motor sizes	STANDARD COLUMN								OPTIONAL COLUMN	ØD0	ØD2	ØD1			X-Ød			
SV15	PV	137	285	153	900	1200 1800	500	500	450	450	205	18	174	1113	675	248	629	285	280	127	40	98	4-Ø16
SV15R		1113																					
SV25	QV	227	399	231	1200	1200 1500	680	680	620	620	285	18	265	1390	794	290	681	432	350	178	65	140	4-Ø19
SV25R		1396																					
SV40	RV	265	538	317	1500	1200 1800	1000	870	800	930	400	22	393	1803	1020	416	960	867	350	229	100	191	8-Ø19
SV40R		1809																					
SV60	SV	390	670	365	1800	1500 2100	1100	1100	1030	1030	500	28	475	2186	1200	476	1011	1737	350	280	150	241	8-Ø22
SV60R		2194																					
SV80	SV	450	805	440	1800	1500 2100	1300	1200	1100	1200	600	28	550	2191	1300	476	1011	2800	350	343	200	298	8-Ø22
SV80R						2191																	
SV100	TV	500	500	470	2100	1800 2400	1750	1450	1350	1650	700	48	685	2572	1750	561	1246	3700	400	406	250	362	12-Ø25
SV100R						2572																	
SV120	TV	500	1170	559	2100	1800 2400	1750	1450	1350	1650	700	48	700	2476	1750	561	1246	400	483	300	432	12-Ø25	
SV120R		2832																					

NOTE: L size: 300, 600, 900, 1200, 1800 R dimension range: 50-300 mm

*All dimensions (mm) **Dimenions subject to change without notice

NOTE This information is for guidance/reference only. For application specific drawings and curves, please contact your nearest authorised distributor at slurrypro.com